



## 55-inch Class 4K UHD LCD Display TH-55SQE1W

### Product specification (design and specification are subject to change without notice)

#### DISPLAY PANEL

Screen Size (Diagonal)	55-inch class (1387.8 mm)
Panel type / Backlight	IPS / Direct-LED
Aspect ratio	16:9
Effective Display Area (W x H)	1209.6 x 680.4 mm (47.62" x 26.78")
Resolution (H x V)	3840 x 2160
Brightness (Typ)	500 cd/m <sup>2</sup>
Contrast Ratio	1200:1
Dynamic Contrast Ratio	50000:1
Max. Display Colors	Approx. 1.07 Billion
Response Time (Typ)	8 ms (G to G)
Viewing Angle (Horizontal / Vertical)	178° / 178° (CR>10)
Panel Life Time* <sup>1</sup> (Typ)	Approx. 50000 hours
Panel Surface Treatment	Anti-glare type (Haze 1%)

\*1 When the panel lifetime is at 50% of the brightness under the condition of 25 degrees Celsius (+/- 2 degrees Celsius).

#### CONNECTION TERMINAL

HDMI IN	HDMI Connector x 4	Compatible with HDCP 2.2
DisplayPort 1.2a Input	x 1	Compatible with HDCP 1.3
DisplayPort 1.2a Output	x 1	Compatible with HDCP 1.3
PC IN	Mini D-Sub 15-pin (DDC2B) x 1	RGB : 0.7 V <sub>p-p</sub> (75 Ω) HD/VD : TTL (High impedance)
SERIAL IN	D-sub 9pin (Female) x 1, RS-232C Compatible	
IR IN	Stereo mini jack (M3) x 1	
AUDIO IN	Pin jack (L / R) x 1	
AUDIO OUT	Stereo mini Jack (M3) x 1 SPDIF x 1	
LAN	RJ45 x 1	
USB	USB connector Type-A (5 V/0.5 A) x 2, Type-C (5 V/1.5 A) x 1 (Internal) Type-A x 1	
SLOT	Intel <sup>®</sup> SDM specification Corresponding size SDM-S / SDM-L, Supply power 40 W	
Wi-Fi	Built-in	

#### AUDIO

Built in Speaker	16 W [8W + 8W]
------------------	----------------

#### ELECTRICAL

Power Requirements	AC 110 - 127 V 50 Hz / 60 Hz AC 220 - 240 V 50 Hz / 60 Hz
Power Consumption	197 W (SLOT not in use:143 W)
On Mode Average Power Consumption*	123 W
Power Off Condition	0 W
Stand-by Condition	Approx. 0.5 W
Apparent power	197 W (SLOT not in use:144 W) (AC 110-127 V) 197 W (SLOT not in use:144 W) (AC 220-240 V)
Energy efficiency class for Europe	< G <sup>A</sup> <sub>8</sub>

\*Based on IEC 62087 Ed.2 measurement method

#### MECHANICAL

Dimension (W x H x D) Not including remote controller sensor box	1239 x 712 x 104 mm (48.75" x 28.02" x 4.09")
Dimension (W x H x D) Including remote controller sensor box	1239 x 730 x 104 mm (48.75" x 28.74" x 4.09")
Weight	17.2 kg (38.0 lbs)
Carton Dimensions (W x H x D)	1369 x 874 x 165 mm (53.90" x 34.41" x 6.50")
Gross Weight	24 kg (53.0 lbs)
Cabinet Material	Front: Metal / Side, Back: Plastic
Bezel Color	Black
Bezel Width	T/R/L 12.3 mm (0.48") B 15.1 mm (0.59")
Pitch for Wall-Hanging	VESA Compliant 400 x 200 mm (15.8" x 7.9") (Installed by: M6 screws / Screw hole depth 13 mm (0.52"))

\*Remote IR sensor is detachable.

#### INSTALLATION

Orientation*	Landscape / Portrait
Tilting Angle	Landscape : 20 degrees forward Portrait : 20 degrees forward

\*Please contact your sales representative with regard to the tilt angle before installation.

#### ENVIRONMENTAL

Operating Environment	Temperature : 0°C to 40°C (32°F to 104°F) <sup>*1</sup> ; 0°C to 35°C (32°F to 95°F) <sup>*2</sup> Humidity : 20% to 80% (No condensation)
Storage Environment	Temperature : -20°C to 60°C (-4°F to 140°F) Humidity : 20% to 80% (No condensation)

\*1 : for up to 1400 m (4593 ft) altitude \*2 : for between 1400 m (4593 ft) and 2800 m (9186 ft) altitude

• Depending on the temperature or humidity conditions, uneven brightness may be observed. This is not a malfunction.

• This unevenness will disappear while applying current continuously. If not, consult the distributor.

UPC Code	885170428058
----------	--------------

**MAIN FEATURE**

Wireless Display	Yes
USB Media Player	Yes
Data Cloning	USB
Multi display settings	Yes
Power on Screen Delay	Yes
Auto setting	Yes
No signal power off	Yes
HDMI power management (HDMI-Wakeup)	Yes
Button lock	Yes
Operation level control	Yes
Set up timer	Yes
SERIAL control (RS232C)	Yes
LAN control	Yes
HDMI CEC Compatible	Yes
Crestron Connected™	Yes
SNMP	Yes
PJLink™	Yes
Multi Monitoring & Control Software	Yes (It will be supported in Dec 2020)
Memory Viewer	Yes
HTML5 Browser	Yes
HTML5 Browser auto-Launch	Yes
Real Time Clock	Yes
Pixel shift	Yes
OSD Rotation	Yes
USB Auto-play (Type A&C)	Yes
Operating Time*	24h/day

\*Displaying a still image for a long time may cause burn-in (image persistence artifacts), it could be mitigated when display video image.

**STANDARD (CERTIFICATIONS)**

SAFETY REGULATIONS	EU/AUS/NZ/USA CB Report (LVD; IEC62368-1 2nd Edition + EU/AUS/NZ/USA Deviation) EU Deviation : EN62368-1:2014 2nd Edition AUS/NZ Deviation : AUS/NZ AUS/NZS62368-1:2018 2nd Edition USA Deviation : UL62368-1-2014, 2nd Edition UL Certification
RADIATION REGULATIONS	EU : EMC test report [Class-A] (CE; EN55032:2012/EN61000-3-2:2014/EN61000-3-3:2013/EN55024:2010 IEC61000-4-2:2008 IEC61000-4-3:2010 IEC61000-4-4:2012 IEC61000-4-5:2005 IEC61000-4-6:2013 IEC61000-4-8:2009 IEC61000-4-11:2004) AUS : RCM-CISPR32 test report [Class-A] US : FCC [Class-A]

**WIRELESS LAN FUNCTION**

Compliance standard	IEEE 802.11 a/b/g/n Dual (Wireless LAN Standard protocol) Wi-Fi CERTIFIED
Channel	IEEE802.11a/b/g/n
Communication distance	Approx. 30 m (Depends on usage environment)

**REMOTE CONTROL TRANSMITTER**

Power Requirements	DC 3 V (AA Size batteries x 2)
Operating distance	Approx. 7 m (22.9 ft)*
Weight	Approx. 111 g (4 oz) including batteries
Dimensions (W x H x D)	51 x 161 x 27 mm (2" x 6.4" x 1.1")

\*When operated directly in front of the IR sensor.

**INCLUDED ACCESSORIES**

- Remote Control x 1 - IR Sensor x 1 - IR Sensor Holder
- Screw (for IR Sensor's Holder) x 2 - Power Supply Code
- Batteries x 2: AA/R6/LR6 type - Cable Clamper x 3
- Spacer x 4 - Screw for spacer x 4

Cautions: This drawing is not a scale  
Units : mm (inches)

**DIMENSIONS**

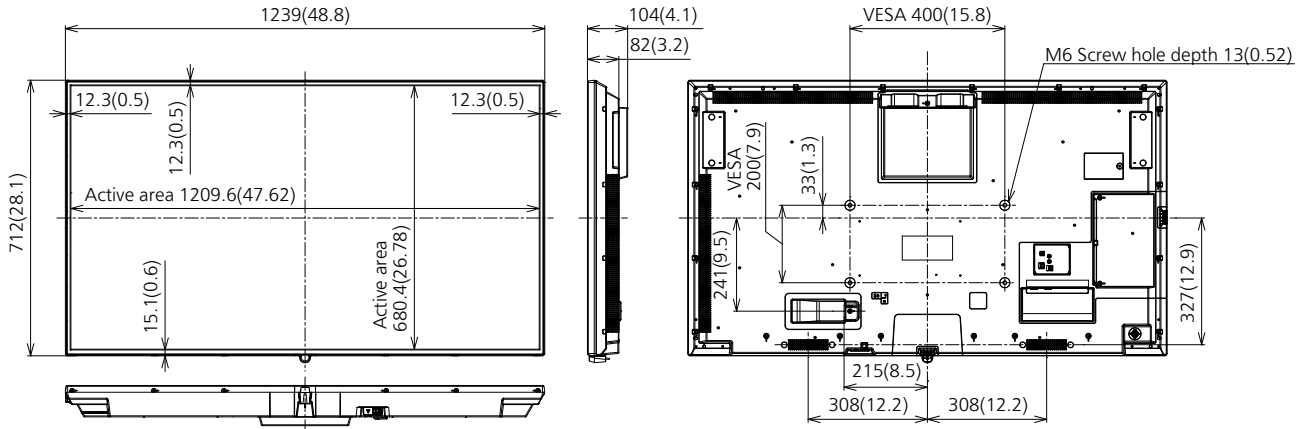

**CONNECTION TERMINAL**

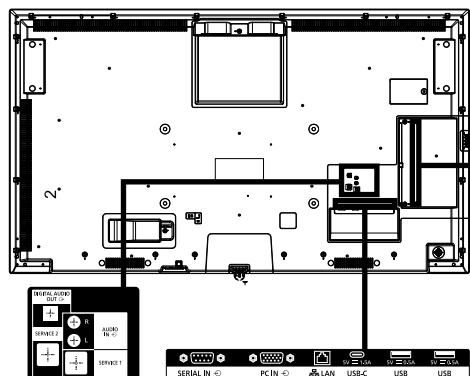

\* Specifications and appearance are subject to change without notice.

Supported signals & TV format

Corresponding Signal	Resolution (Dot)	Scanning frequency		Dot Clock frequency (MHz)	Format <sup>2</sup>	Plug and Play supported signal			
		Horizontal (kHz)	Vertical (Hz)			HDMI	DP <sup>3</sup>	Type-C	PC
480/60i	720(1440) x 480i <sup>11</sup>	15.73	59.94	27	H/DP/TypeC	○	○	○	-
576/50i	720(1440) x 576i <sup>11</sup>	15.63	50	27	H/DP/TypeC	○	○	○	-
480/60p	720 x 483	31.47	59.94	27	H/DP/TypeC	○	○	○	-
576/50p	720 x 576	31.25	50	27	H/DP/TypeC	○	○	○	-
720/60p	1280 x 720	45	60	74.25	H/DP/TypeC	○	○	○	-
720/50p	1280 x 720	37.5	50	74.25	H/DP/TypeC	○	○	○	-
1080/60i	1920 x 1080i	33.75	60	74.25	H/DP/TypeC	○	○	○	-
1080/50i	1920 x 1080i	28.13	50	74.25	H/DP/TypeC	○	○	○	-
1080/24p	1920 x 1080	27	24	74.25	H/DP/TypeC	○	○	○	-
1080/25p	1920 x 1080	28.13	25	74.25	H/DP/TypeC	○	○	○	-
1080/30p	1920 x 1080	33.75	30	74.25	H/DP/TypeC	○	○	○	-
1080/60p	1920 x 1080	67.5	60	148.5	H/DP/TypeC	○	○	○	-
1080/50p	1920 x 1080	56.25	50	148.5	H/DP/TypeC	○	○	○	-
2K/24p	2048 x 1080	27	24	74.25	H/DP/TypeC	-	-	-	-
2K/25p	2048 x 1080	28.13	25	74.25	H/DP/TypeC	-	-	-	-
2K/30p	2048 x 1080	33.75	30	74.25	H/DP/TypeC	-	-	-	-
2K/48p	2048 x 1080	54	48	148.5	H/DP/TypeC	-	-	-	-
2K/60p	2048 x 1080	67.5	60	148.5	H/DP/TypeC	-	-	-	-
2K/50p	2048 x 1080	56.25	50	148.5	H/DP/TypeC	-	-	-	-
3840 x 2160/24p	3840 x 2160	54	24	297	H/DP/TypeC	○	○	○	-
3840 x 2160/25p	3840 x 2160	56.25	25	297	H/DP/TypeC	○	○	○	-
3840 x 2160/30p	3840 x 2160	67.5	30	297	H/DP/TypeC	○	○	○	-
3840 x 2160/60p	3840 x 2160	135	60	594	H/TypeC	○	-	○	-
3840 x 2160/50p	3840 x 2160	112.5	50	594	H/TypeC	○	-	○	-
4096 x 2160/24p	4096 x 2160	54	24	297	H/DP/TypeC	○	○	○	-
4096 x 2160/25p	4096 x 2160	56.25	25	297	H/DP/TypeC	○	○	○	-
4096 x 2160/30p	4096 x 2160	67.5	30	297	H/DP/TypeC	○	○	○	-
4096 x 2160/60p	4096 x 2160	135	60	594	H/TypeC	○	-	○	-
4096 x 2160/50p	4096 x 2160	112.5	50	594	H/TypeC	○	-	○	-
640 x 400/70	640 x 400	31.47	70.09	25.18	H/DP/TypeC/PC	-	-	-	-
640 x 400/85	640 x 400	37.86	85.08	31.5	H/DP/TypeC	-	-	-	-
640 x 480/60	640 x 480	31.47	59.94	25.18	H/DP/TypeC/PC	○	○	○	○
640 x 480/67	640 x 480	35	66.67	30.24	H/DP/TypeC/PC	-	-	-	-
640 x 480/73	640 x 480	37.86	72.81	31.5	H/DP/TypeC/PC	-	-	-	-
640 x 480/75	640 x 480	37.5	75	31.5	H/DP/TypeC/PC	-	-	-	-
640 x 480/85	640 x 480	43.27	85.01	36	H/DP/TypeC/PC	-	-	-	-
800 x 600/56	800 x 600	35.16	56.25	36	H/DP/TypeC/PC	-	-	-	-
800 x 600/60	800 x 600	37.88	60.32	40	H/DP/TypeC/PC	○	○	○	○
800 x 600/72	800 x 600	48.08	72.19	50	H/DP/TypeC/PC	-	-	-	-
800 x 600/75	800 x 600	46.88	75	49.5	H/DP/TypeC/PC	-	-	-	-
800 x 600/85	800 x 600	53.67	85.06	56.25	H/DP/TypeC/PC	-	-	-	-
832 x 624/75	832 x 624	49.72	74.55	57.28	H/DP/TypeC/PC	-	-	-	-
852 x 480/60	852 x 480	31.47	59.94	34.24	H/DP/TypeC	-	-	-	-
1024 x 768/50	1024 x 768	39.55	50	51.89	H/DP/TypeC	-	-	-	-
1024 x 768/60	1024 x 768	48.36	60	65	H/DP/TypeC/PC	○	○	○	○
1024 x 768/70	1024 x 768	56.48	70.07	75	H/DP/TypeC/PC	-	-	-	-
1024 x 768/82	1024 x 768	65.55	81.63	86	H/DP/TypeC/PC	-	-	-	-
1024 x 768/85	1024 x 768	68.68	85	94.5	H/DP/TypeC/PC	-	-	-	-
1066 x 600/60	1066 x 600	37.64	59.94	53	H/DP/TypeC	-	-	-	-
1152 x 864/60	1152 x 864	53.7	60	81.62	H/DP/TypeC/PC	-	-	-	○
1152 x 864/70	1152 x 864	63.99	70.02	94.2	H/DP/TypeC/PC	-	-	-	-
1152 x 864/75	1152 x 864	67.5	75	108	H/DP/TypeC/PC	-	-	-	-
1152 x 864/85	1152 x 864	77.09	85	119.65	H/DP/TypeC/PC	-	-	-	-
1152 x 870/75	1152 x 870	68.68	75.06	100	H/DP/TypeC/PC	-	-	-	-
1280 x 720/60	1280 x 720	44.76	60	74.48	H/DP/TypeC/PC	-	-	-	○
1280 x 768/50	1280 x 768	39.55	49.94	65.18	H/DP/TypeC	-	-	-	-
1280 x 768/60	1280 x 768	47.7	60	80.14	H/DP/TypeC	-	-	-	-
1280 x 768/60	1280 x 768	47.78	59.87	79.5	H/DP/TypeC/PC	-	-	-	-
1280 x 800/50	1280 x 800	41.2	50	68.56	H/DP/TypeC	-	-	-	-
1280 x 800/60	1280 x 800	49.31	59.91	71	H/DP/TypeC	-	-	-	-
1280 x 800/60	1280 x 800	49.7	59.81	83.5	H/DP/TypeC	-	-	-	○
1280 x 960/60	1280 x 960	60	60	108	H/DP/TypeC/PC	-	-	-	-
1280 x 960/85	1280 x 960	85.94	85	148.5	H/DP/TypeC	-	-	-	-
1280 x 1024/60	1280 x 1024	63.98	60.02	108	H/DP/TypeC/PC	○	○	○	○
1280 x 1024/75	1280 x 1024	79.98	75.02	135	H/DP/TypeC/PC	-	-	-	-
1280 x 1024/85	1280 x 1024	91.15	85.02	157.5	H/DP/TypeC/PC	-	-	-	-
1360 x 768/60	1360 x 768	47.71	60.02	85.5	H/DP/TypeC	-	-	-	-
1360 x 768/60	1360 x 768	47.7	60	84.72	H/DP/TypeC	-	-	-	-
1360 x 768/60	1360 x 768	47.72	59.8	84.75	H/DP/TypeC	-	-	-	-
1366 x 768/50	1366 x 768	39.55	50	69.92	H/DP/TypeC	-	-	-	-
1366 x 768/60	1366 x 768	48.39	60.03	86.71	H/DP/TypeC	-	-	-	-
1366 x 768/60	1366 x 768	48	60	72	H/DP/TypeC	-	-	-	-
1366 x 768/50	1366 x 768	39.56	49.89	69	H/DP/TypeC	-	-	-	-
1366 x 768/60	1366 x 768	47.71	59.79	85.5	H/DP/TypeC/PC	-	-	-	-
1400 x 1050/60	1400 x 1050	65.22	60	122.61	H/DP/TypeC	-	-	-	-
1400 x 1050/75	1400 x 1050	82.2	75	155.85	H/DP/TypeC/PC	-	-	-	-
1440 x 900/60	1440 x 900	55.47	59.9	88.75	H/DP/TypeC	-	-	-	-
1440 x 900/60	1440 x 900	55.92	60	106.47	H/DP/TypeC/PC	-	-	-	-
1600 x 900/50	1600 x 900	46.3	50	97.05	H/DP/TypeC	-	-	-	-
1600 x 900/60	1600 x 900	60	60	108	H/DP/TypeC	-	-	-	○
1600 x 900/60	1600 x 900	55.99	59.95	118.25	H/DP/TypeC	-	-	-	-

Corresponding Signal	Resolution (Dot)	Scanning frequency		Dot Clock frequency (MHz)	Format*2	Plug and Play supported signal			
		Horizontal (kHz)	Vertical (Hz)			HDMI	DP*3	Type-C	PC
1600 x 900/60	1600 x 900	55.92	60	119	H/DP/TypeC	-	-	-	-
1600 x 1200/60	1600 x 1200	75	60	162	H/DP/TypeC/PC	-	-	-	○
1680 x 1050/60	1680 x 1050	65.29	59.95	146.25	H/DP/TypeC	-	-	-	-
1920 x 1080/60	1920 x 1080	66.59	59.93	138.5	H/DP/TypeC	-	-	-	-
1920 x 1080/60	1920 x 1080	67.5	60	148.5	H/DP/TypeC/PC	○	○	○	○
1920 x 1200/60	1920 x 1200	74.04	59.95	154	H/DP/TypeC/PC	○	○	○	○

\*1 : Pixel-Repetition signal (dot clock frequency 27.0 MHz) only

\*2 : Following characters are abbreviation of input terminals.

H : HDMI (HDMI 1, 2, 3, 4)  
 DP : Display Port  
 Type-C : USB Type-C  
 PC : D-sub RGB

\*3 : Only for SQE1W

\*4 : Signals with ○ in the Plug and Play-supported signal column are the ones written in EDID (Extended Display Identification Data) of this unit.

For signals without ○ in the Plug and Play-supported signal column, resolutions may not be selected on the PC side even if this unit supports those signals.

Note

- An auto detected signal format may be differently displayed from the actual input signal.
- The i symbols (example 1080i) means Interlaced signal.

● Terminals

View from back

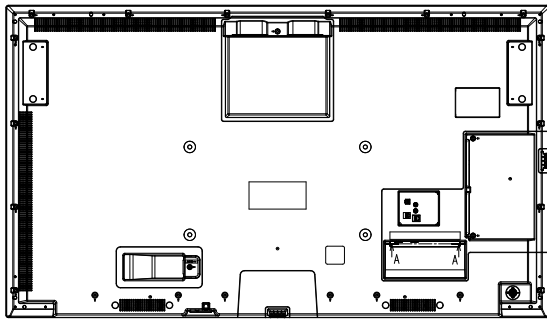

Magnified figure of terminal b

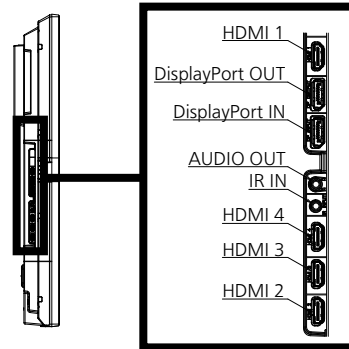

Magnified figure of terminal a

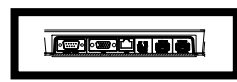
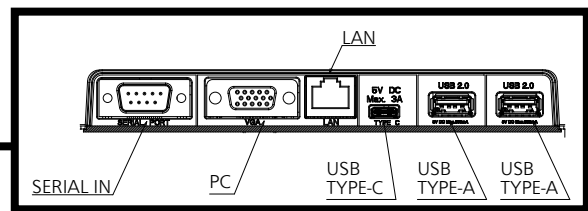

SECTION A-A

Sectional view of terminal a  
(SERIAL / PC / LAN / USB TYPE-C / USB TYPE-A)

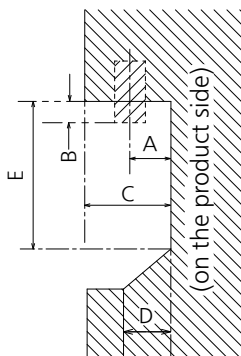

Terminal a  
55SQE1W Terminal (Bottom) Units : mm (inch)

	SERIAL / PC	LAN	USB TYPE-C	USB TYPE-A
A	9.3 (0.37)	9.7 (0.38)	4.8 (0.19)	6.6 (0.26)
B	3.7 (0.15)	—	—	—
C	26.6 (1.05)			
D	9.4 (0.37)			
E	65.9 (2.59)			

Sectional view of terminal b  
(HDMI / DisplayPort / IR / AUDIO OUT)

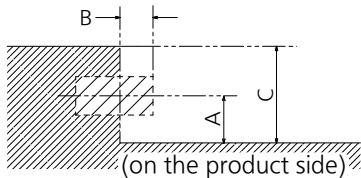

Terminal b  
55SQE1W Terminal (Side) Units : mm (inch)

	HDMI	DisplayPort	IR / AUDIO OUT
A	7.1 (0.28)	5.1 (0.20)	6.2 (0.25)
B	—	—	0.8 (0.03)
C	25.1 (0.99)		

\*Since clearance between terminals are limited, some USB connector will not fit.  
Please check if USB memory devices you are going to use will fit, using the diagram above.