

# INSTALLATION MANUAL

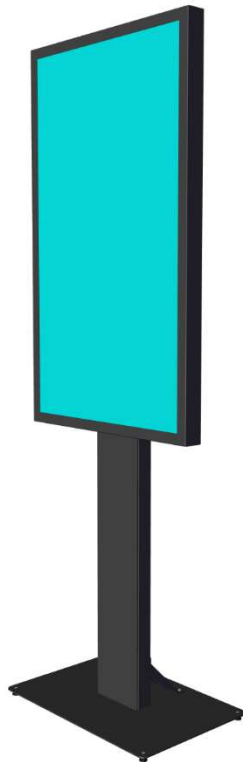







Product nr: FS5515-5001-01

FS5515-5001-02

FS5512-5001-01

FS5512-5001-02

S2 M6 (4x)	S3 M4 (8x)
	
	
	
	

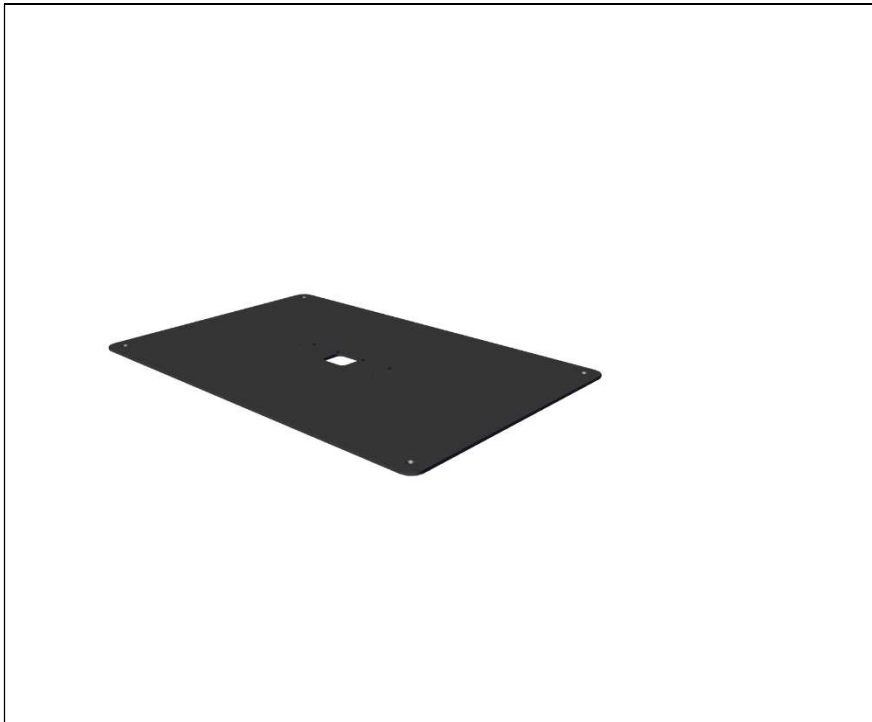

1.Start with the bottom plate



2.Attach the feets with screws from the top of the bottom plate



3. Image of screws attached to the bottom plate

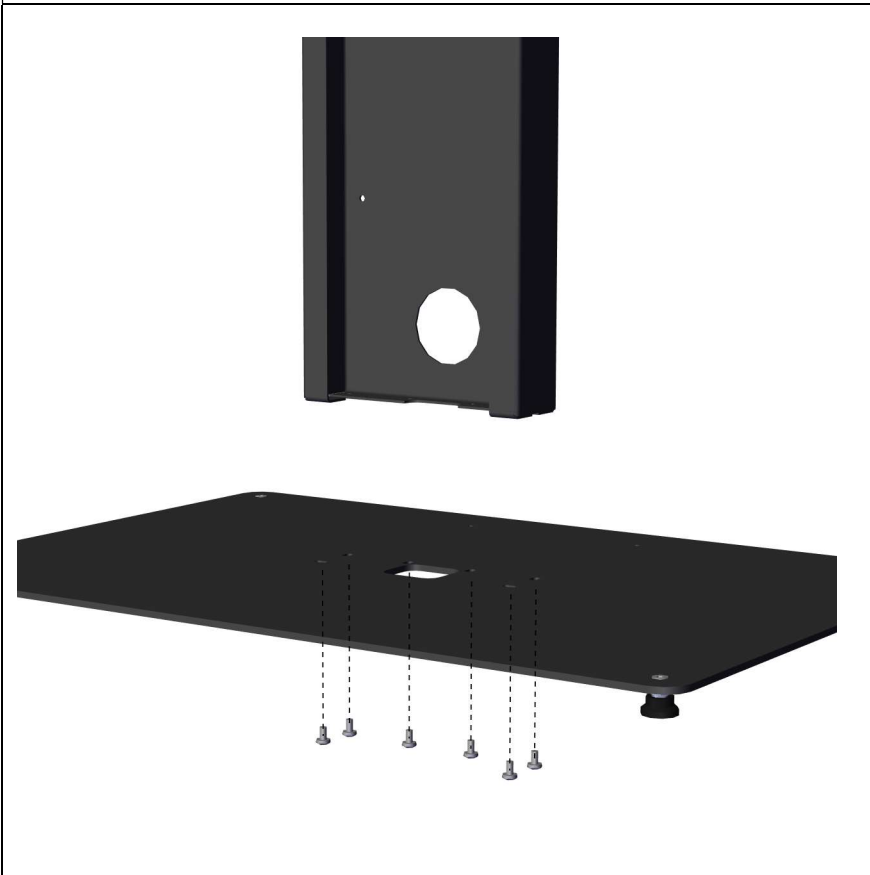

4. Connect the pillar to the bottom plate

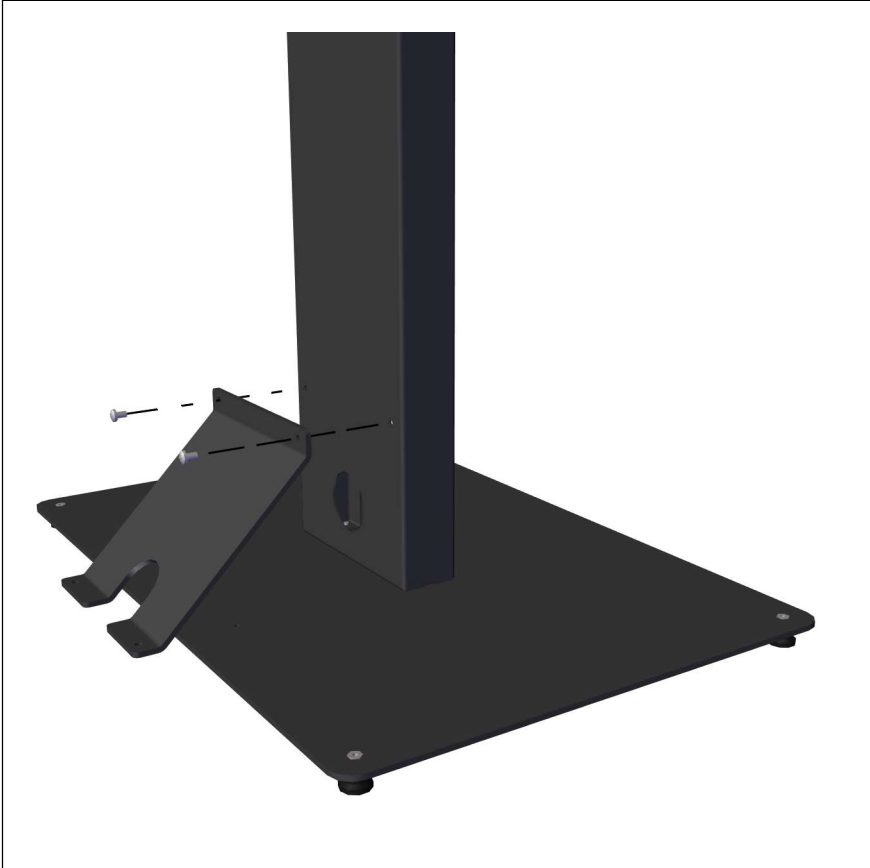

5. Connect the backside plate to increase stability



6. Connect the backside plate to increase stability

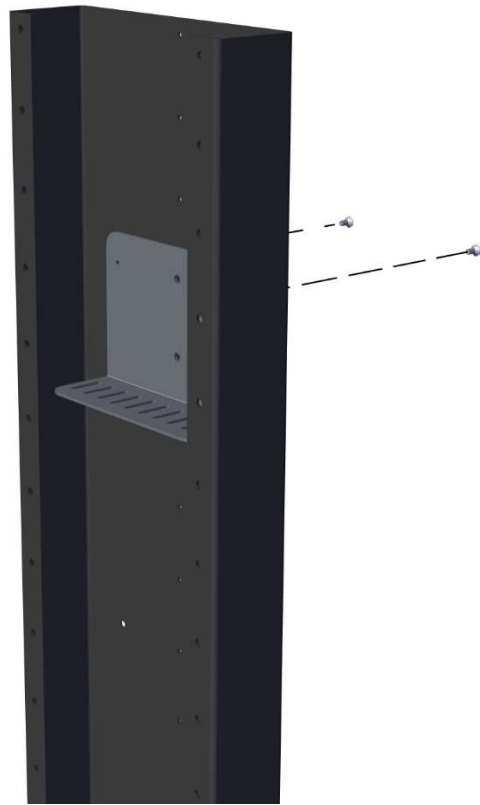

7. Connect the hatch inside the pillar if external equipment is needed

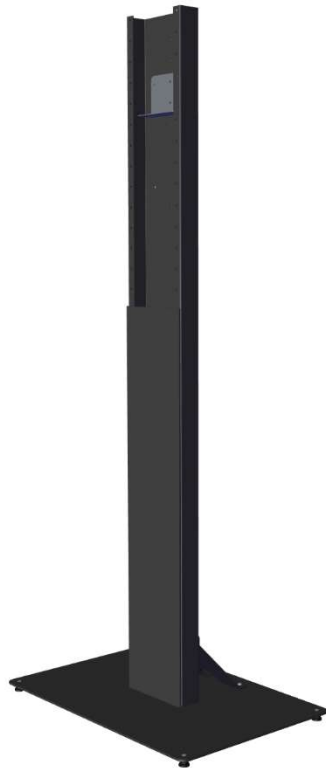

8. Hatch and pillar is now finished

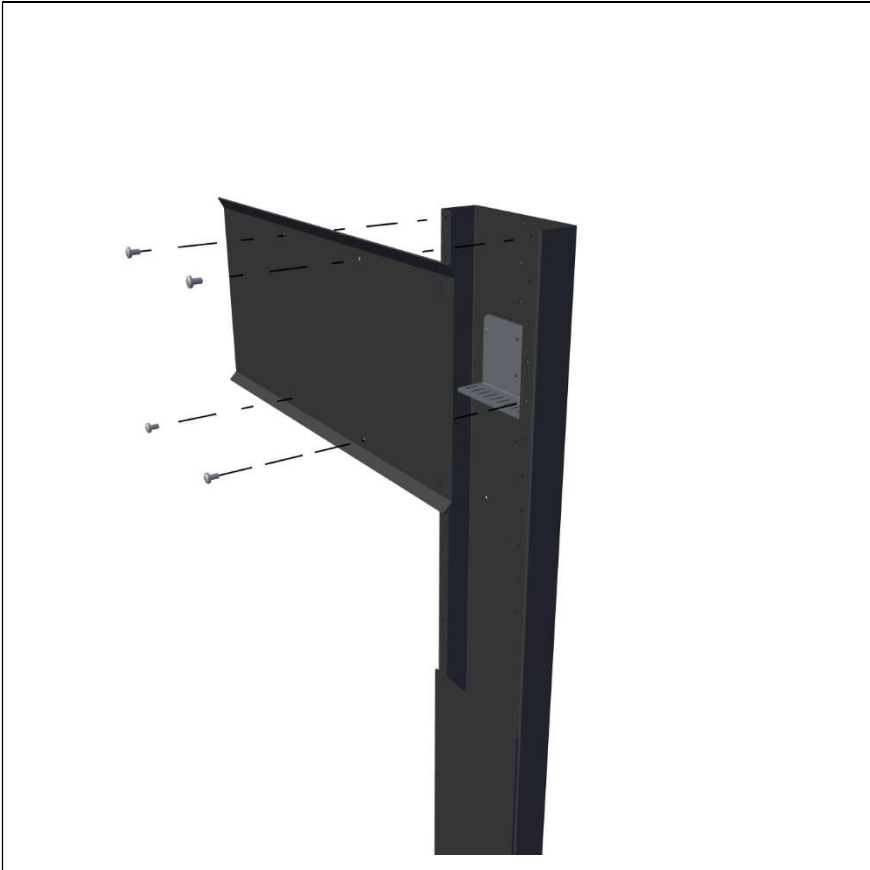

9. Attach the mount to the pillar



10. Image to show the mount connected to the pillar

11. Connect the VESA brackets to the screen

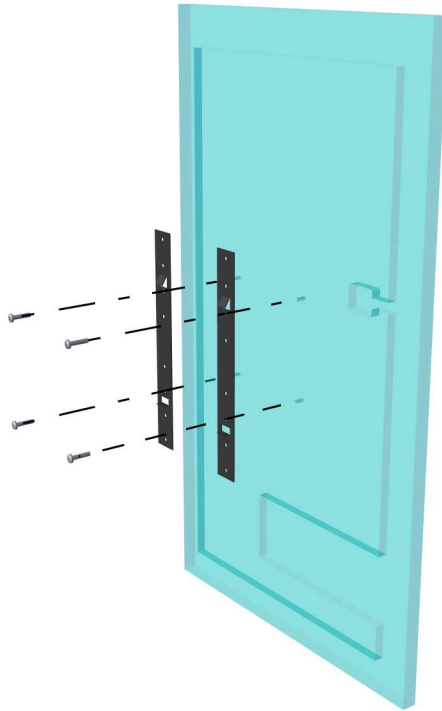

12. Screen can now be attached to the floorstand

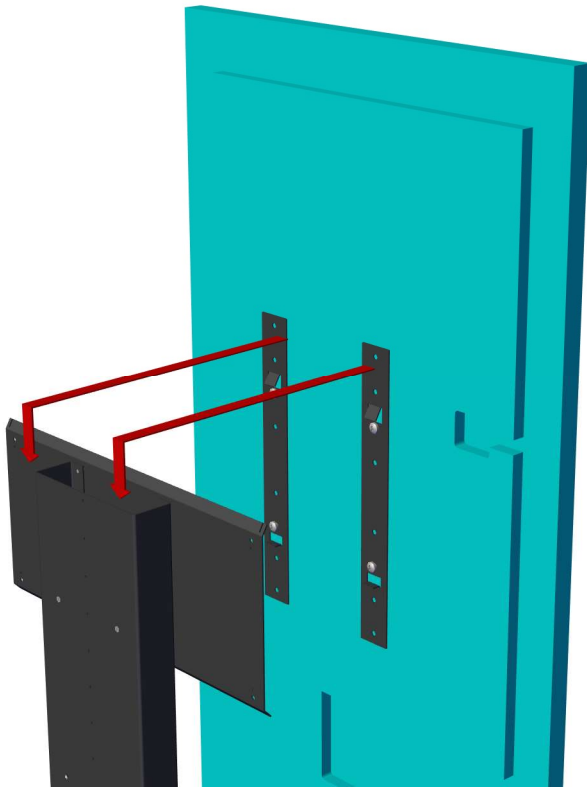



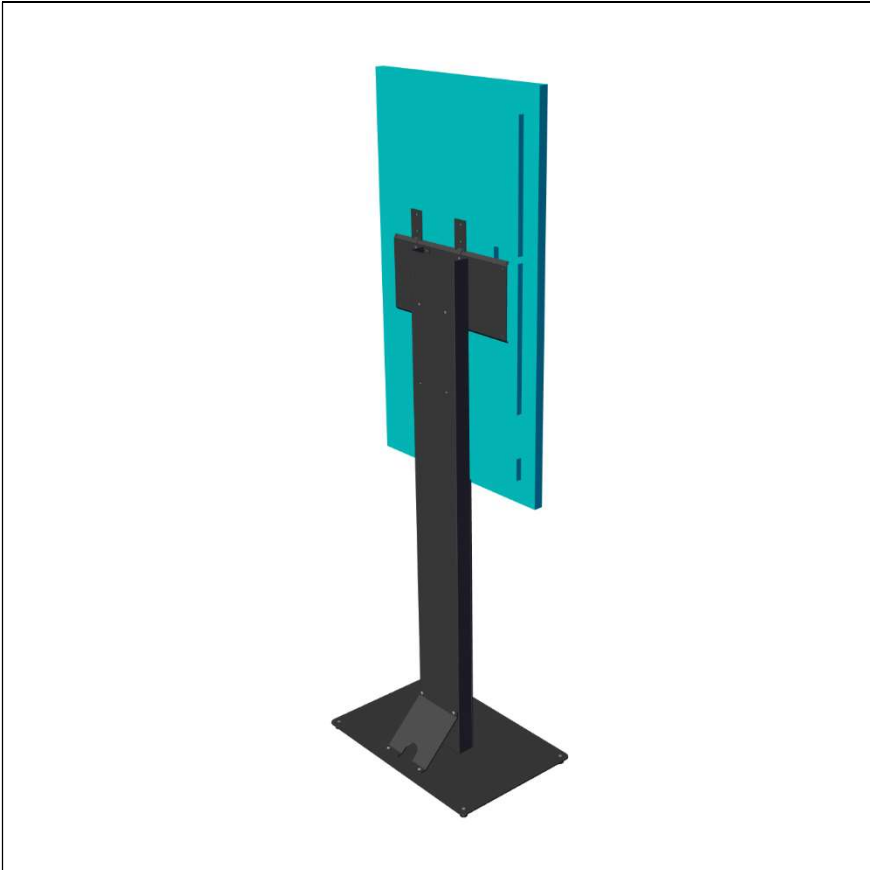

13. Floorstand Universal glass is now finished.

Follow the guide below for information how backcover and frontcover are connected

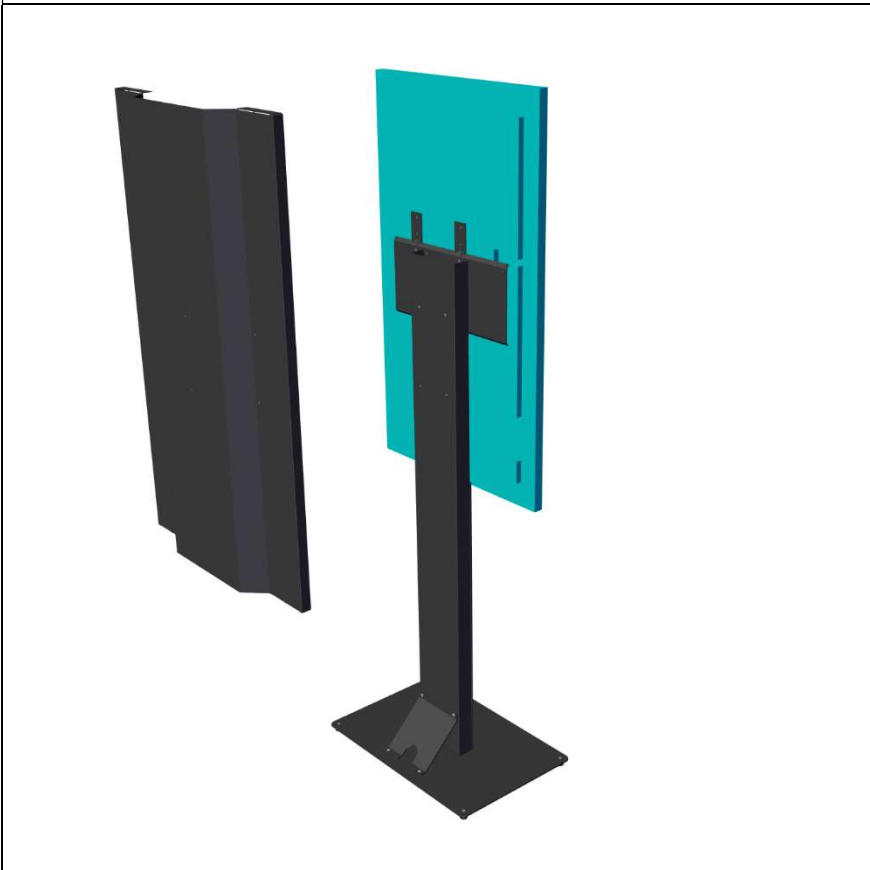

14. Connect the backcover

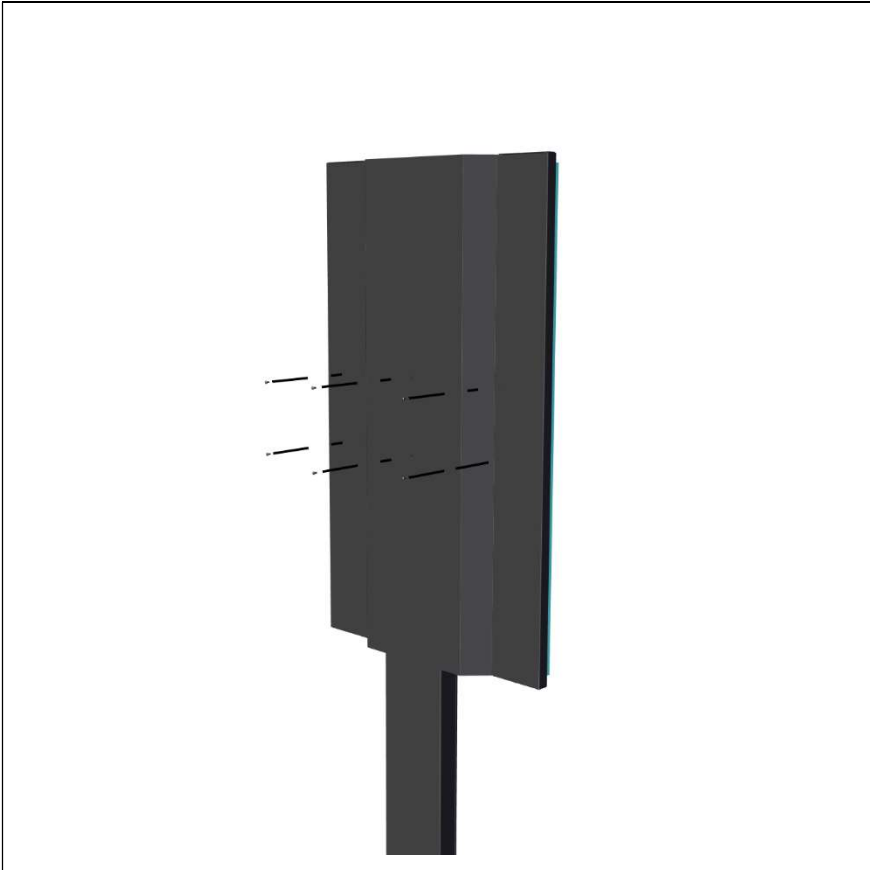

15. Backcover is now connected

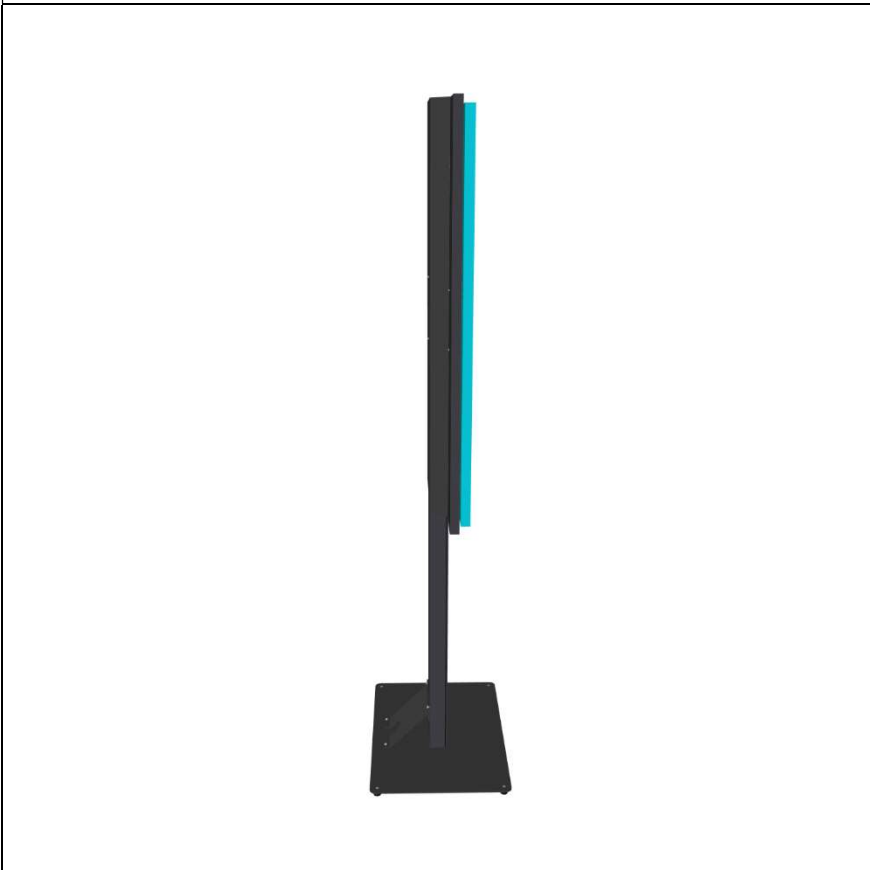

16. Floorstand with backcover is now finished.  
Follow the guide for installation of frontcover

17. Frontcover is attached to the front of the screen

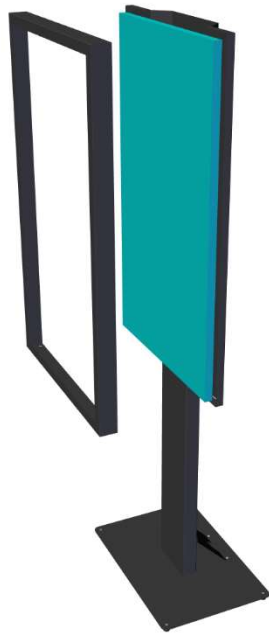

18. Screws are connected on top

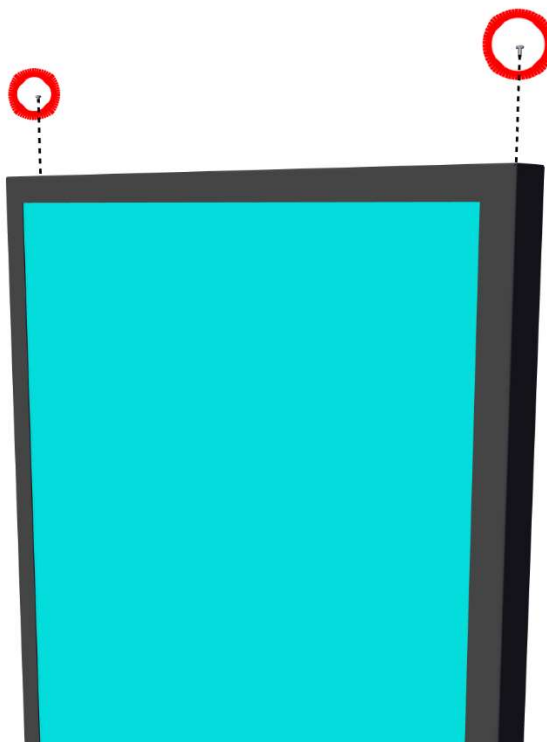

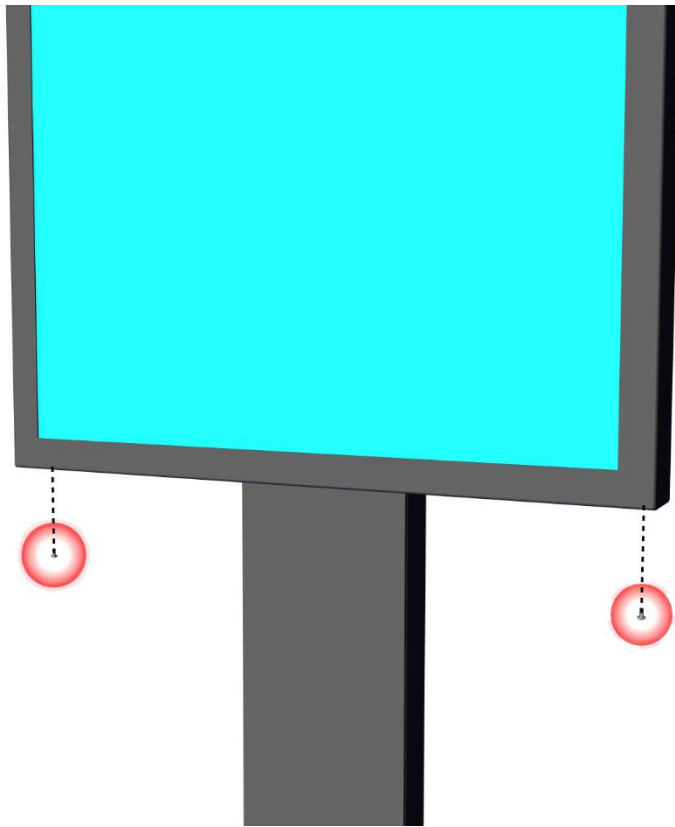

19. Screws are connected to the bottom

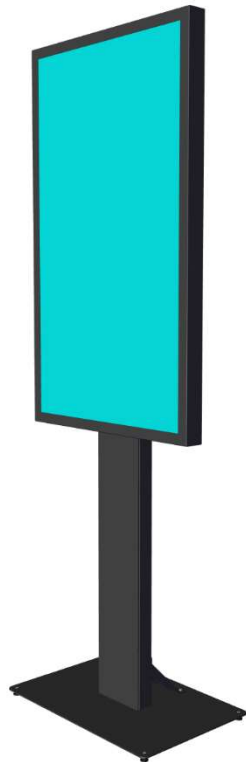

20. Floorstand glass with frontcover and backcover is now finished