

newline **FLEX**

User Manual

TT-2721AIO

Before using this product, please carefully read through this manual and keep for later reference

Table of Contents

Product introduction	2
Product appearance	2
Packing list	2
Unpacking FLEX	3
Tilt backwards by 45° in the normal condition	3
Rubber stopper	3
Camera	4
SDM board selection	4
Description of Stylus Pen	4
Installation of Stylus Pen	5
Use	5
Description of keys	5
Description of interfaces	6
USB Type - C feature comparison	6
Connecting Flex to desktop computer or notebook	7
Connect mobile phone	8
Audio output	8
Audio input	8
OSD function	9
Considerations	9
Troubleshooting	10
Healthy eyes	10
Low blue light details	10
Basic parameters	11
Energy efficiency labeling	12
Name and content of hazardous substances included in products	12
Warranty clauses	13

Product introduction

• Product appearance

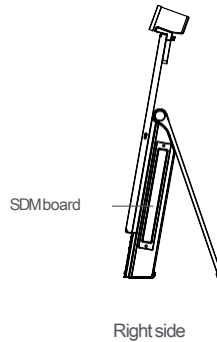
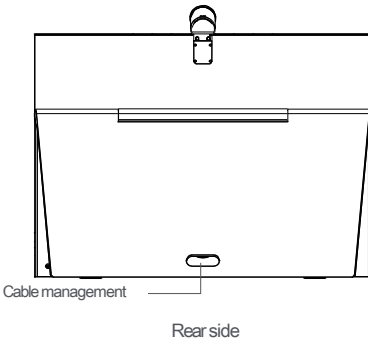
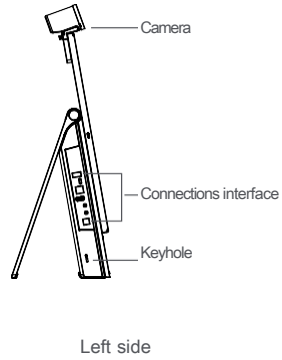
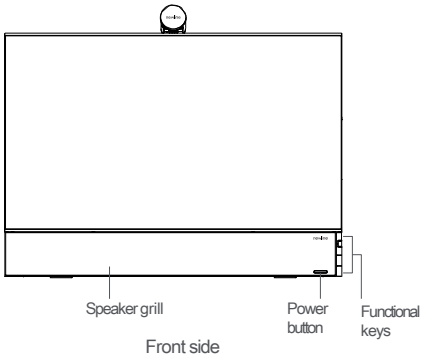

• Packinglist

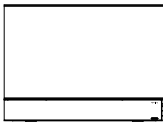

Flex Display X1

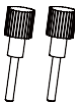

Thumb screw X2



Power cord 1.5M X1



Type C cable X1

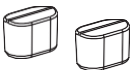

Rubber stopper X2

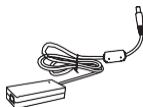

Adapter X1



Stylus Pen X1

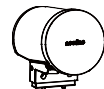

Camera X1

• Unpacking FLEX

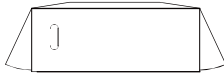

1. Lay the carton flat and take out the top cover of the carton.

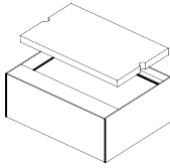

2. Take out the upper protective cushion.

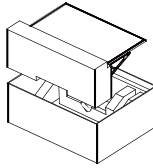

3. Take out FLEX and the protective cushion out of the carton.

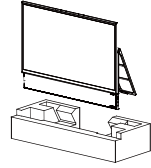

4. Remove FLEX out of the protective cushion.

• Tilt backwards by 45° in the normal condition

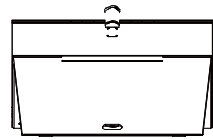
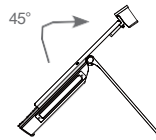
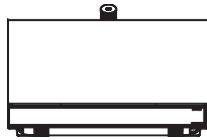

Rubber stopper (optional)

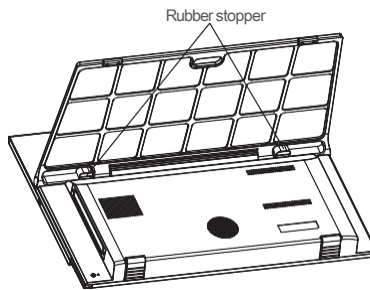
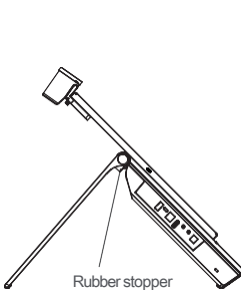

Installation procedure:

Open the rear bracket to the maximum angle, and then attach two "rubber stoppers" on the left and right recesses of the rear bracket.

Function: "rubber stoppers" are used to limit the angle of FLEX rear bracket, so as to avoid the possibility of machine damage due to tilting forward caused by accidental collision with FLEX.

• **Camera**

Camera usage 1: keep the camera facing forward, align the socket position with the base slot, and then tighten two thumb screws by hand.

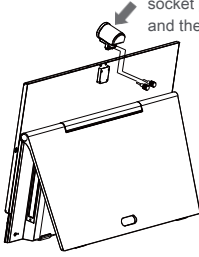

Camera usage 2: keep the camera facing backward, align the socket position with the base slot, and then tighten two thumb screws by hand.

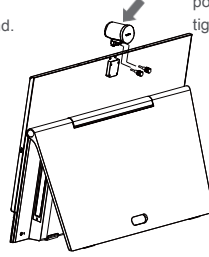

• **SDM board selection**

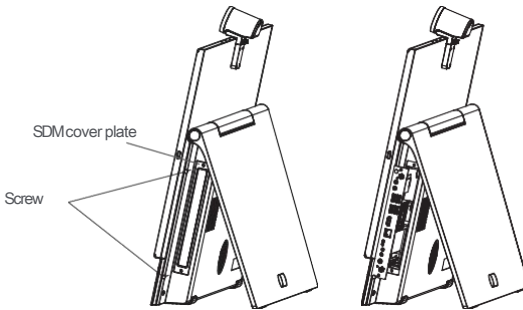

Installation procedure:

1. Remove the two screws on the SDM cover plate and take down the SDM cover plate.
2. Align both sides of the SDM plate with the guide grooves and push it to the bottom.
3. Then lock the SDM plate onto the complete device with two screws.

Note: SDM is a additional accessory.

• **Details of Stylus Pen**

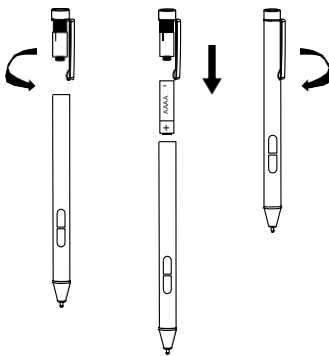

Microsoft Surface Pro Compliant Stylus

·Battery: AAAA alkaline battery

·Pressure Level: 1024

·Hover height: BH 10mm

·Pen's protocol: Microsoft's Protocol

·Side Button Function:

A Right-click button

Acts just like right-clicking a mouse.

Press and hold to select text in apps like Windows OneNote.

B Eraser button

Press and hold for erase function in apps like Windows OneNote.

Power saving function:

Idle mode: Inactiveness after 5 minutes, press the pen tip or button to wake up the pen.

1. Locate the Battery Compartment
2. Insert in AAAA Battery
3. Lock battery compartment firmly

• Installation of Stylus Pen

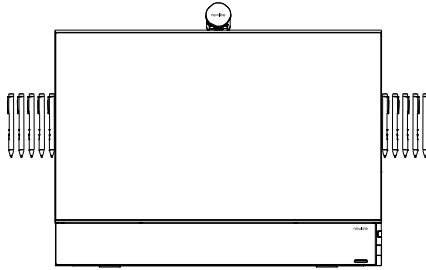

Magnetically attach the stylus pen body onto the aluminum frame on the side of the Flex display.

Use

• Description of keys

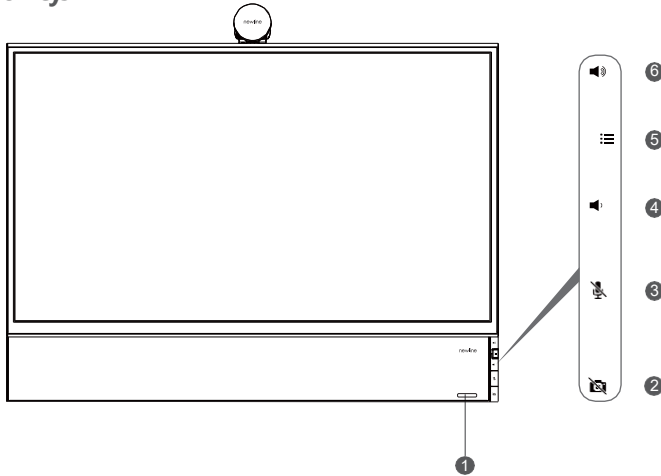

Control buttons

Control description

- ① Power switch
- ② Camera switch
- ③ Microphones switch
- ④ Volume -
- ⑤ Menu
- ⑥ Volume +

Switch system: if presence of SDM, the machine is started up synchronously when power is supplied to SDM. There are two turn-off modes. When test shows presence of SDM, jump to the SDM channel. The complete device will be turned off after the SDM is turned off. If absence of SDM, the machine is immediately turned off.

Activate/deactivate the camera: the Activate/deactivate the camera icon pops up and stays for 1 s. If the camera is deactivated, the red indicator goes on; if it is activated, no indicator goes on

Activate/deactivate the microphone: the Activate/deactivate the microphone icon pops up and stays for 1 s. If the microphone is deactivated, the red indicator goes on; if it is activated, no indicator goes on

Shortcut button for turning down the volume. The sound adjustment icon pops up and stays for 3 s

Call up the OSD main menu

Shortcut button for turning up the volume. The sound adjustment icon pops up and stays for 3 s

• Description of interfaces

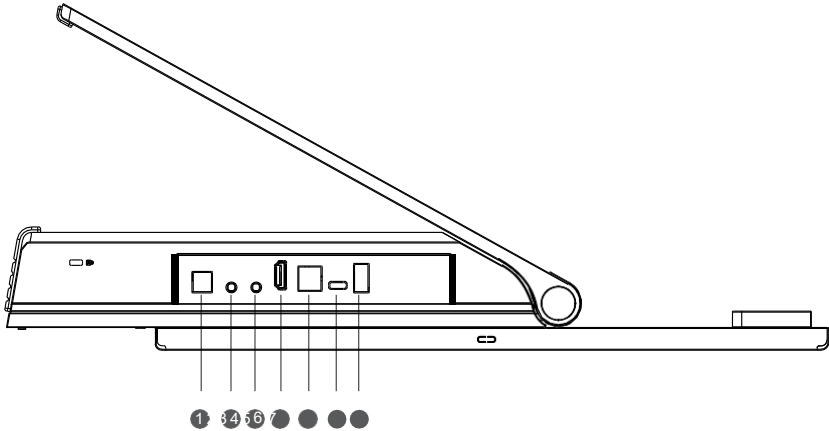

- | | | |
|---|------------|---|
| ① | 19.5V | Power adapter 19.5V input |
| ② | AUDIO OUT | Audio output (headset) |
| ③ | AUDIO IN | Audio input |
| ④ | HDMI IN | HDMI input |
| ⑤ | USB-Type-B | External device touch control input |
| ⑥ | TYPE-C | Type-C Input Supports fast charging and audio/video/touch/data |
| ⑦ | USB 3.0 | USB Device Hub - HDMI/SDM/Type-C channel common switching interface |

• USB Type-C feature comparison

USB mark	USB Version name	Data transfer	Audio transfer	Video transfer	Touch control signal	Power transmission
	USB 2.0 High Speed	✓				
	USB 3.1 Gen 1 (original USB 3.0) Super Speed	✓	✓	✓	✓	
	USB 3.1 Gen 1 (original USB 3.0) Super Speed	✓	✓	✓	✓	
	USB 3.1 Gen 1 (original USB 3.0) Super Speed	✓	✓	✓	✓	✓
	USB 3.1 Gen 1 (original USB 3.0) Super Speed	✓	✓	✓	✓	✓
	Thunderbolt 3	✓	✓	✓	✓	✓

• **Connect Flex display to desktop computer or notebook**

Method 1: (Type-C cable +power cable)

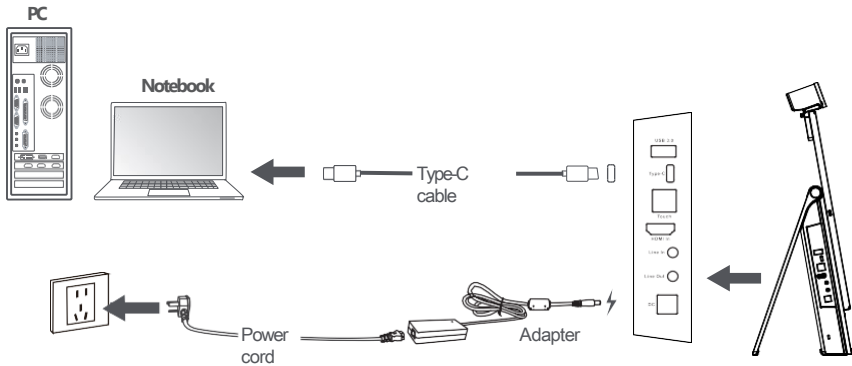

1. Connect one end of the Type-C data cable to the Type-C port of the machine, and the other end to the Type-C port of the PC or notebook.
2. Insert the power cable into the power adapter, and connect it to the DC port of the machine.

Method 2: (HDMI signal cable +USB3.0-A to USB3.0-B cable +power cable)

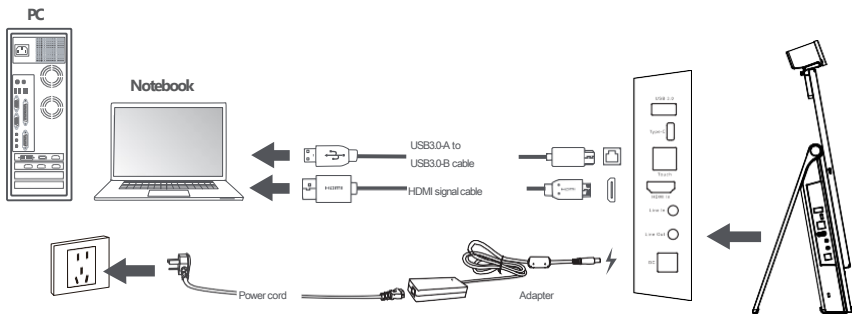

1. Connect the HDMI cable with the HDMI In port of the product and the HDMI output port of the PC or notebook.
2. Insert the power cable into the power adapter, and connect it to the DC port of the machine.
3. Connect PC or notebook to the USB3.0 port of product with a USB3.0-A to USB3.0-B cable.
(Note: The USB3.0-A to USB3.0-B cable and the HDMI cable, which are not included in the standard configuration, have to be purchased separately by the user.)

! Note: If the cables provided together with the machine are defective or damaged, be sure to ask the dealer or manufacturer for the original cable replacements.

• **Connect mobile phone**

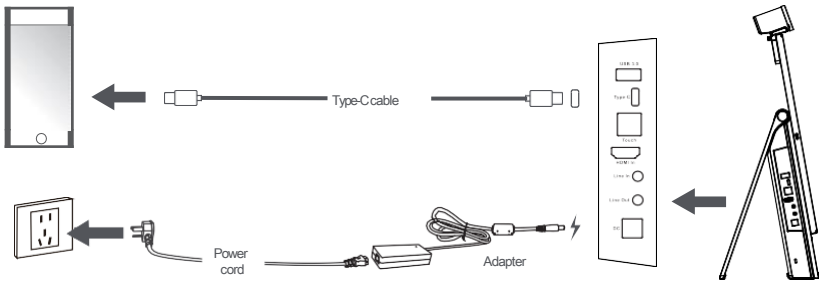

1. Connect the Type-C cable to the Type-C ports of the machine, and connect the other end to the mobile phone.
2. Insert the power cable into the power adapter, and connect it to the DC port of the machine.

• **Audio output**

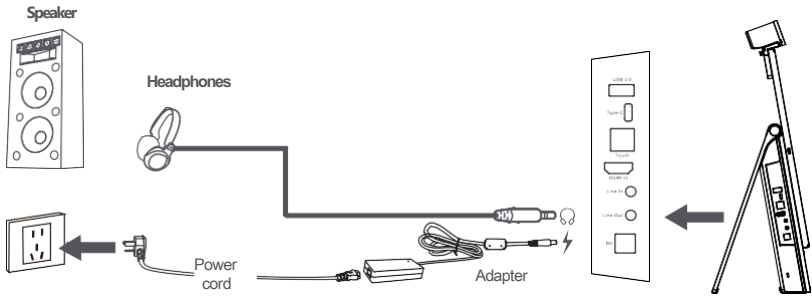

1. Connect a three-section earphone cable to the Line Out port of the machine. Note: the earphone cable is not included in the standard configuration
2. Insert the power cable into the power adapter, and connect it to the DC port of the machine.

• **Audio input**

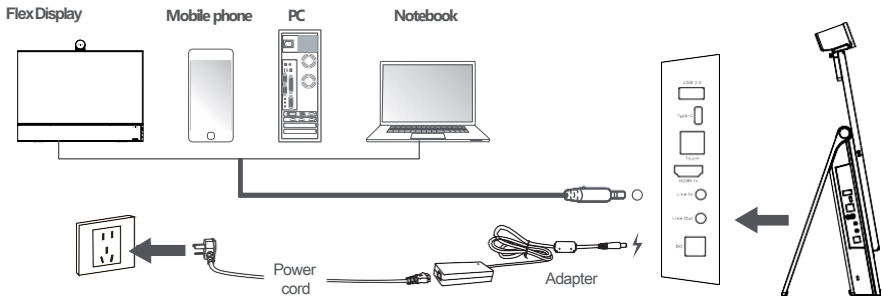

1. Connect a three-section earphone cable to the Line in port of the machine. Note: the Headphone cable is not included in the standard configuration
2. Insert the power cable into the power adapter, and connect it to the DC port of the machine.

· OSD function

Display mode



- | | |
|---|---|
| ① Standard mode: Suitable for browsing websites | ④ Movie mode: Suitable for watching movies |
| ② Graphics mode: Suitable for viewing photos and graphics | ⑤ Night mode: Suitable for night browsing |
| ③ Reading mode: Suitable for viewing documents | ⑥ Eye care mode: Protect the eyes |
| | ⑦ Energy-saving mode: Low power consumption |

Image settings

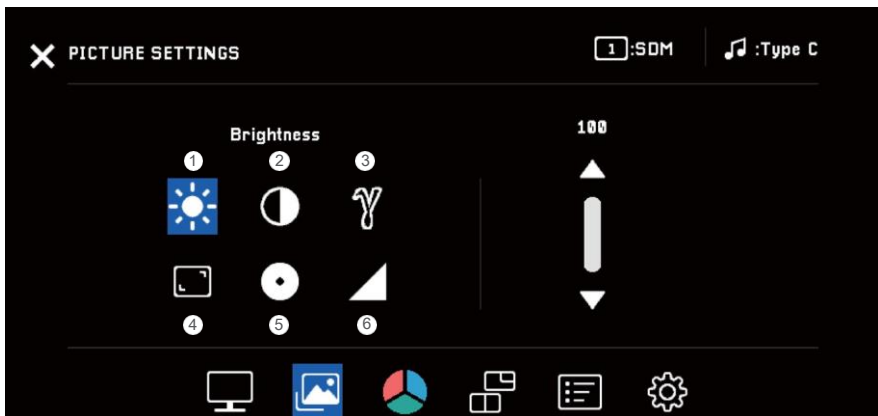

- | | |
|------------------|--|
| ① Brightness: | Adjust the image brightness |
| ② Contrast: | Adjust the image contrast |
| ③ Gamma: | Adjust the median value of brightness |
| ④ Image scale: | Full screen: Enlarge the input image to fill the screen. It is suitable for images with the 16:9 aspect ratio.
4: 3: change the image scale to 4: 3. It is suitable for images with the 4:3 aspect ratio. |
| ⑤ Black balance: | adjust the brightness of the black area |
| ⑥ Sharpness: | adjust the definition of the image |

· OSD function

Color temperature setting

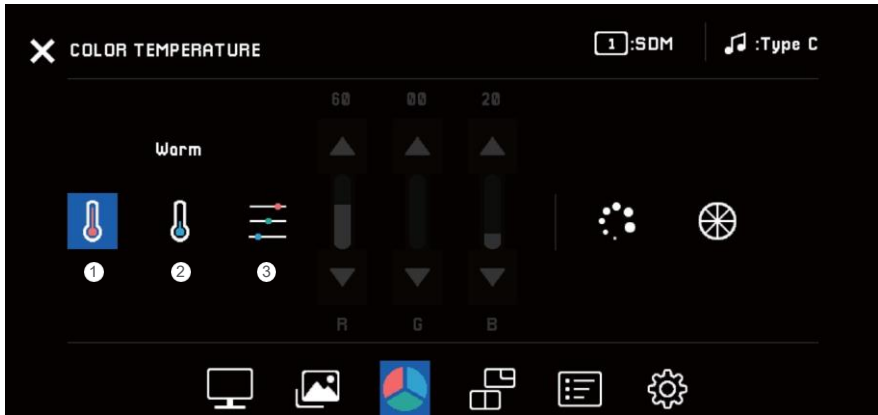

- ① Warm color temperature
- ② Cold color temperature
- ③ Custom color temperature: you can select red (R), green (G) and blue (B) according to your preference in the user customization

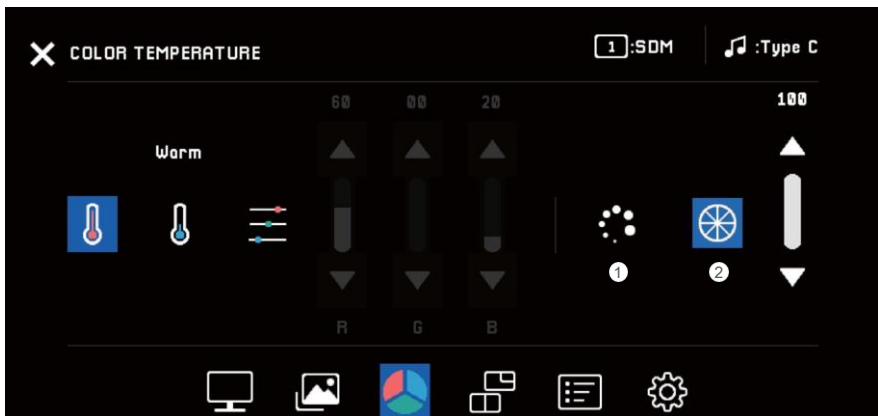

- ① Saturation: Adjust the intensity of the color
- ② Tone: Adjust Image Tone

· OSD function

PIP mode

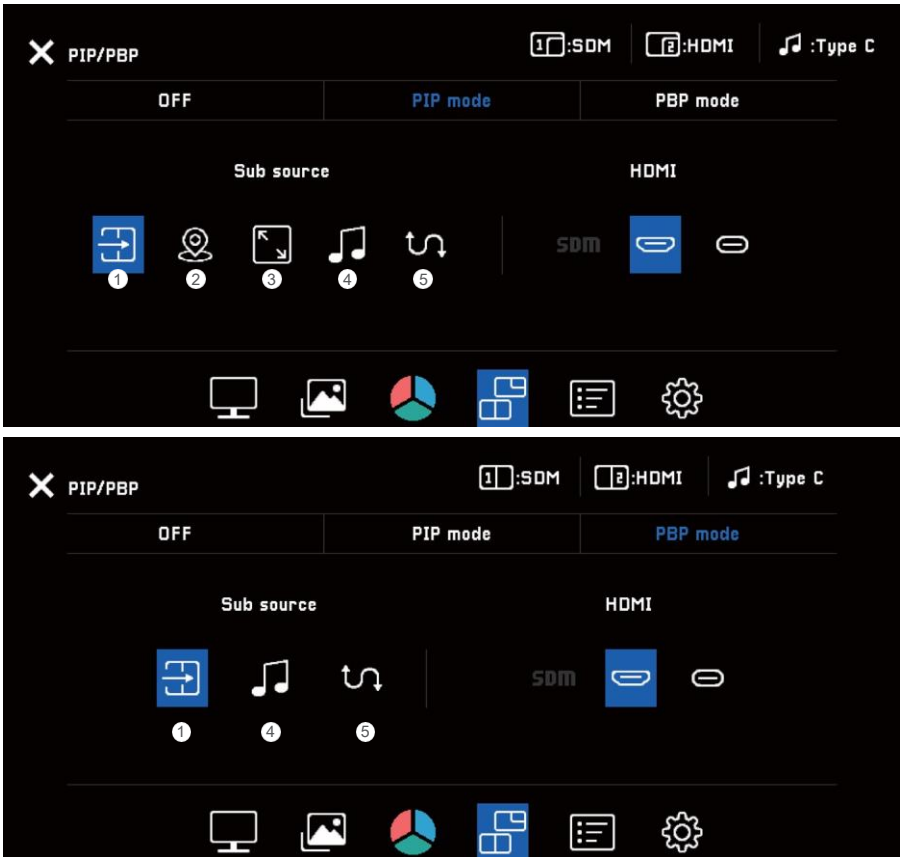

- ① Sub input selection: Select the Sub input source
- ② PIP location: Adjust the PIP location, top left/top right/bottom left/bottom right
- ③ PIP size: Adjust the PIP size
- ④ Sound channel: Select the sound channel
- ⑤ Picture exchange: Main picture and sub-picture swapping

· OSD function

OSD settings

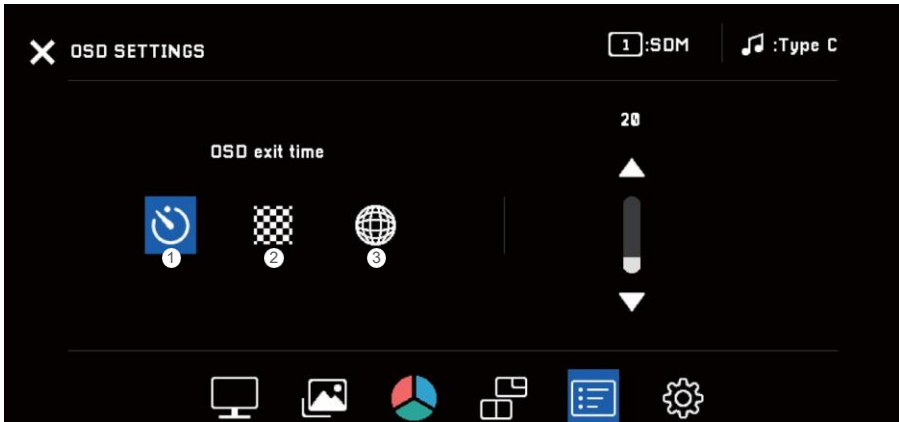

- ① OSD display time: Set the length of time when the OSD menu remains on the screen

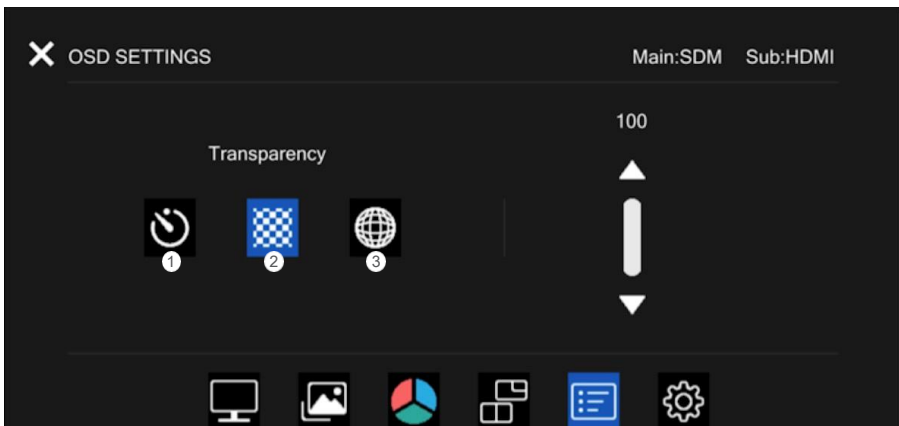

- ② OSD transparency: Adjust the transparency of the OSD menu

· OSD function

OSD settings

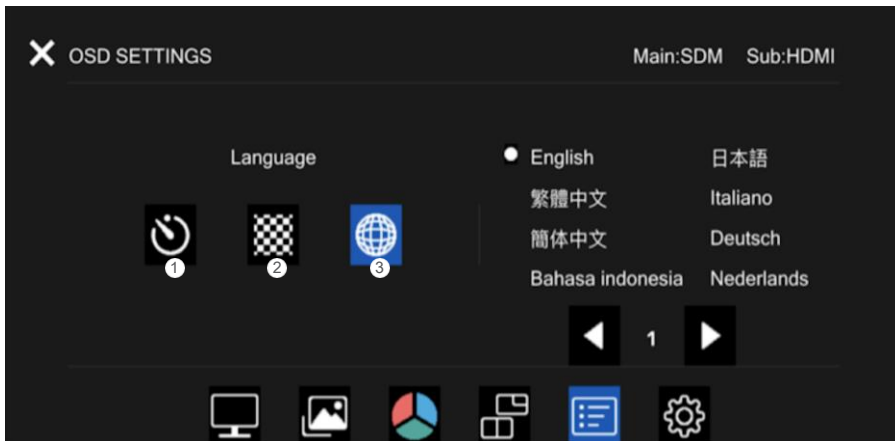

③ LANGUAGE: Select the language available for the OSD menu

Other settings

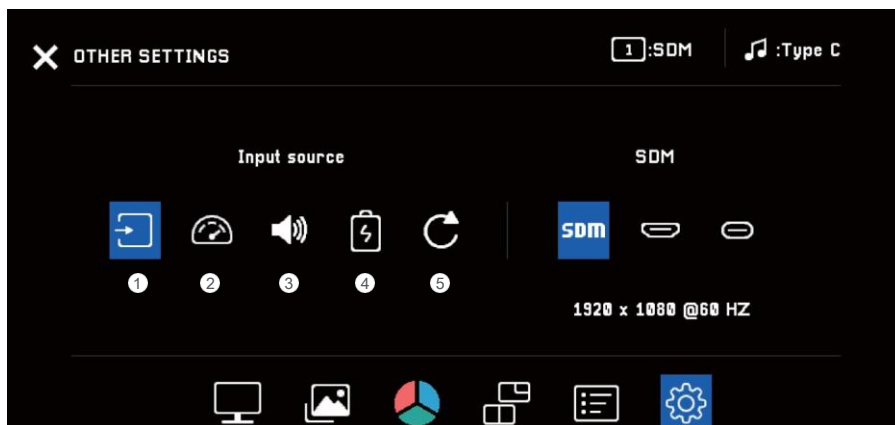

- ① Input signal source: Select the display of the input signal source
- ② Reaction time: Improve the response time of the LCD display
- ③ Audio Mode: Adjust the volume and select the sound mode
- ④ Power charging in standby mode: Type-C charging on/off *
- ⑤ Reset: Restore all OSD settings to the default values

* The Type-C charging function is disabled by default in the energy-saving mode. To charge the product with Type-C, enable it in "Other settings" first.

· OSD function

Other Settings - Input Source

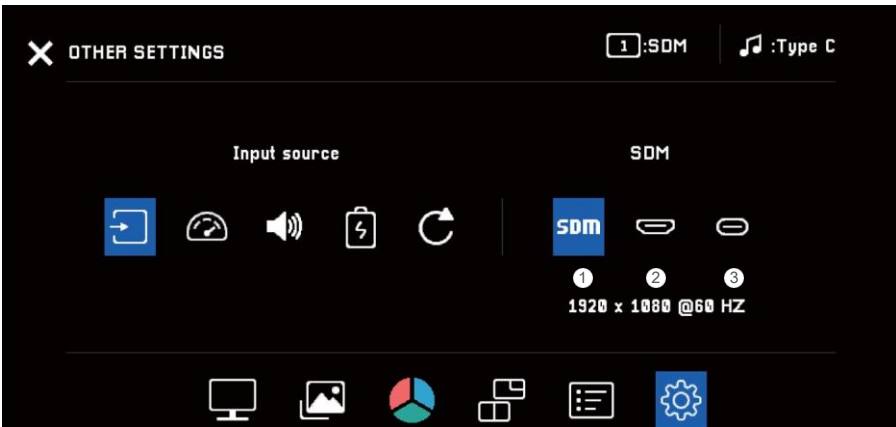

- ① SDM signal source: When you insert SDM module , you can select this signal source
- ② HDMI signal source: When you insert HDMI signal, you can select this signal source
- ③ Type C signal source: When you insert Type C signal, you can select this signal source

Other Settings – Response time

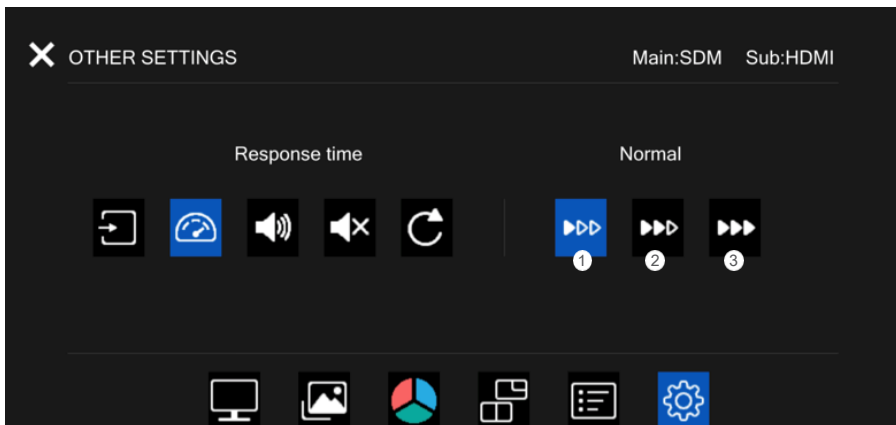

- ① Normal: When select this mode , the display will response in normal
- ② Fast: When select this mode , the display will response faster in 1.5 times
- ③ Faster: When select this mode , the display will response faster in 2.0 times

· OSD function

Other Settings – Audio Mode

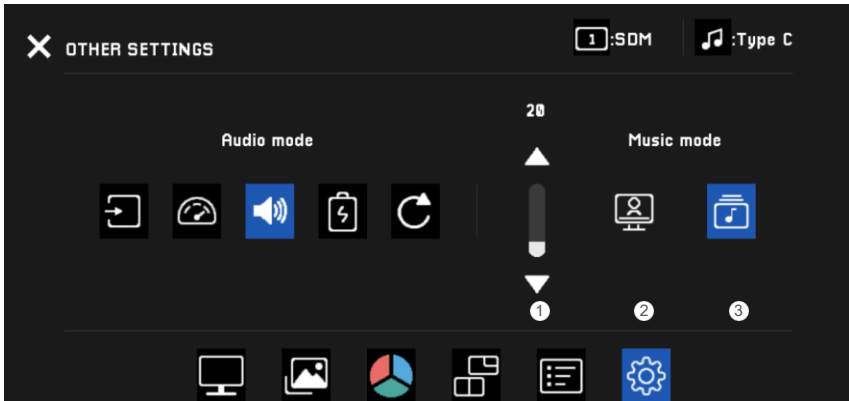

- ① Volume Bar : You can click the bar to adjust the volume
- ② Meeting Mode: You can select this mode when you have meeting
- ③ Music Mode: You can select this mode when you listen music

Other Settings – Power charging in standby mode

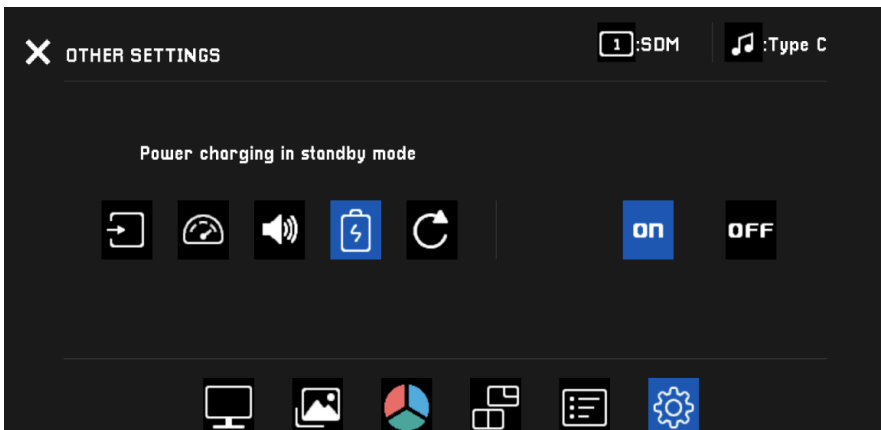

You can select ON/OFF to set power charging

· OSD function

Other Settings – Reset

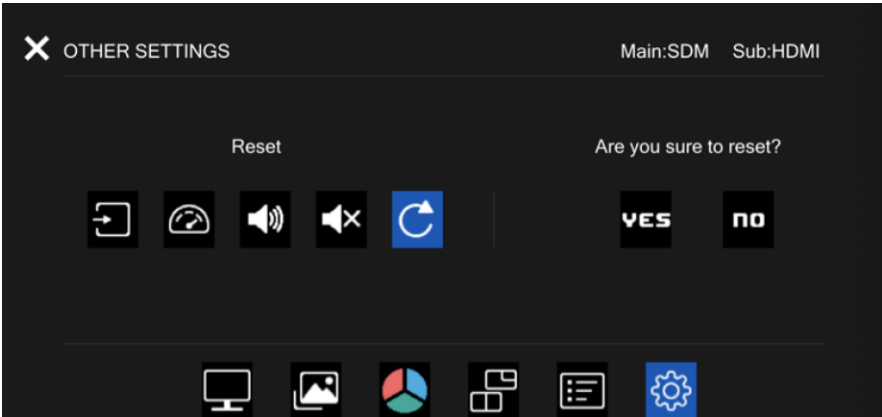

You can select YES/NO to rest

• Special notes

The signal is SDM at the time of startup by default. When other signals are inserted, a prompt box will pop up and remain for 8s for OSD to ask whether to switch to the new signal. (SDM is set to be "Always presence of signals when the machine is on")

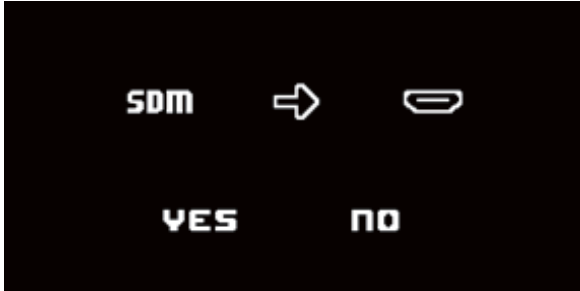

Line OUT access: A prompt box will pop up and remain for 3s for OSD to ask whether to select single and double screen modes. (in the single screen mode, Line Out outputs left and right channels, but the speaker does not have any output. In the double screen mode, both the speaker and Line Out output sounds in one channel.)



Shortcut menu of volume adjustment Press the speaker icon to switch between mute or non-mute (mute can be cleared by adjusting the volume in the mute mode)

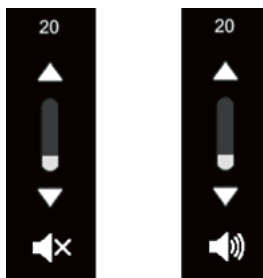

The USB hub switches following the main screen, while the microphone, the camera and the USB switches synchronously following the current signal source.

European energy efficiency pop-up boxes

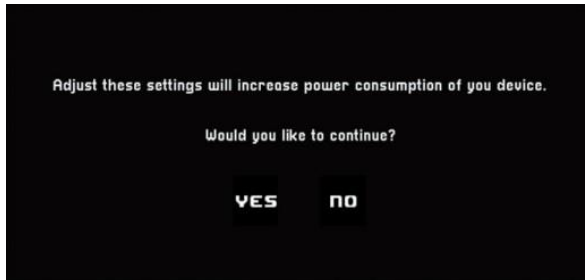

The requirements for pop-up boxes are as follows:

According to the European energy efficiency regulation, the FLEX contextual model is ECO mode, and the luminance contrast and volume are set corresponding to the power supply function of TYPE C. So when you make relevant adjustments, the pop-up window below will appear;

If you are sure you want to adjust the settings, please press "YES", and then the pop-up will not appear again. But if you restore the factory settings, the pop-up window for rear seat adjustment will reappear.

Considerations

- Keep away from water sources or damp places, such as bathrooms, kitchens, basements and swimming pools.
- Ensure that the device is installed and placed on a stable surface. otherwise damage may occur.
- Store and use the product in a cool, dry and well-ventilated place, and keep away from radiation and heat sources. Do not cover or block the vent holes on the back cover, and do not use it on the surface of a bed, sofa, blanket or similar objects.
- The power supply voltage range for the operation of the device is indicated on the label of the back cover. If not sure about the supplied voltage, you can consult the dealer or local electric utility.
- When the device remains idle for a long time, disconnect the power to prevent electric shock and abnormal power voltage damage during thunderstorms.
- Do not overload the socket, otherwise it may cause fire or electric shock.
- Do not put foreign objects into the machine, otherwise it may cause a short circuit which causes a fire or electric shock.
- Do not disassemble or repair this product without authorization. If any malfunction, please contact the after-sales service personnel directly.
- Do not pull or twist the signal and data cables excessively.

Fault details	Causes of faults	Solutions
Unable to start up	The power supply port is not properly connected	<ul style="list-style-type: none"> · Correctly connect the charging cable · Long-press the power key to start up the machine
Type-C not supply power	Type-C power Setting relief	<ul style="list-style-type: none"> · Set the power supply setting of Type-C to "Enabled"
Dim images	The luminance/contrast ratio is not adjusted	<ul style="list-style-type: none"> · Adjust the luminance and the contrast ratio
Jumping image or ripple screen	Interfered	<ul style="list-style-type: none"> · Keep away from electrical equipment that may cause electronic interference
The indicator is not lit up, and no picture is shown	The power cable is not properly connected	<ul style="list-style-type: none"> · Turn on the computer and the all-in-one intelligent conference machine · Insert the computer and the all-in-one intelligent conference machine correctly · Connect the Type-C power cable correctly
The screen displays "Out of range"	Incorrect resolution	<ul style="list-style-type: none"> · Please set the resolution as the recommended value in the basic parameters

Healthy eyes

In order to avoid eye fatigue and neck, arm, elbow, and shoulder pain caused by prolonged use of the monitor, pay attention to the following points in use:

1. Keep you eyes 20 to 28 inches (about 50-70 cm) from the monitor screen.
2. In using the monitor, you are recommended to increase the blinking frequency to relieve eye fatigue.
3. Please take a rest for 20 minutes every two hours.
4. While you are in a rest, take your eyes away from the monitor and look at the distant target for at least 20 s.
5. While you are in a rest, you can stretch to soothe the neck, arms, back, and shoulders.

Low blue light details

In recent years, the damage of blue light to the eyes has attracted more and more attention. Generally, the wavelength of blue ray is 400-480nm, and the wavelength of harmful blue ray is 415-455nm. The display hardware has been designed to effectively reduce the proportion of harmful blue light emission. In addition, the user can enable the eye protection mode for healthy eye use through the menu setting.

Basic parameters

Product name	Flex smart meeting monitor
Product code	TT-2721AIO
Screen size	27 inch
Screen type	AHVA
Resolution	3840×2160
Luminance	≥300 cd/m ²
Touch control	Supported
Loudspeaker	8Ω 5Wx2. Woofer 4Ω 10Wx1
Refresh rate	60Hz
FreeSync	None
Colour gamut	TYP. NTSC 85 %; MAX 95 %
Display color	1.07B Colors
Static contrast ratio	1000 : 1 (typical)
Interface	1 x DC in 19.5V/9.23A 1 x USB3.0 1 x HDMI 2.0(HDCP 2.2) 1 x USB3.0-Type-B 1 x Type-c(Support PD) 1 x line in(jack3.5) 1 x line out(jack3.5)
Overall dimensions	447.2*617.5mm
Product thickness	BH 179,8mm
Net weight	10.3Kg
Input voltage	19.5V/9.23A
Ambient temperature	-20°C ~ 60°C

Energy efficiency labeling

According to the Chinese mainland's "Measures for the Administration of Energy Efficiency Labels", the display meets the following requirements:

Energy efficiency (cd/W)	1.5
OFF-state energy consumption (W)	0.50
Sleep state power (W)	0.50
Energy efficiency grade	Grade 2
Energy efficiency standard	GB 21520-2015

Name and content of hazardous substances included in products

Marking Requirements for the Control of Pollution Caused by Electronic Information Products in China (China's RoHS regulatory marking requirements)

Name and content of hazardous substances included in products

Component name	Harmful substances					
	Lead (Pb)	Mercury (Hg)	Cadmium (Cd)	Hexavalent chromium (Cr(VI))	Polybrominated biphenyls (PBB)	Polybrominated diphenyl ethers (PBDE)
Printed circuit board assembly*	X	○	○	○	○	○
Liquid crystal display	X	○	○	○	○	○
Power cable/Connector	X	○	○	○	○	○
Output/Input device	X	○	○	○	○	○
Loudspeaker	X	○	○	○	○	○
Metallic structural part	X	○	○	○	○	○
Plastic structural parts/Other	○	○	○	○	○	○
Accessories Power cable	X	○	○	○	○	○

This form is prepared in accordance with SJ / T 11364.

○: Indicates that the content of the hazardous substance in all homogeneous materials of the component is below the limit specified in GB/T 26572.

×: Indicates that the content of the hazardous substance in at least one of the homogeneous materials of the component exceeds

the limit specified in GB/T 26572, but all components comply with EU RoHS requirements.

* Printed circuit board assembly: including the printed circuit board and its parts and components.

■ The toxic and hazardous substances or elements in the list above may include more or less substances or elements according to the differences in the components of the model.

■ If there is an environmentally-friendly use period mark on the body of the product component, the main body mark shall prevail.



Warranty clauses

I. Limitation of Warranty:

NEWLINE provides a 12-month warranty for the complete device and national warranty (excluding Hong Kong, Macao and Taiwan). Cables have a 1-month warranty from the invoice date. If no valid invoice for product purchase is available, the production date marked in the product serial number shall prevail.

II. Repair Services:

The original machine under warranty shall be repaired by NEWLINE. If the product is no longer sold or cannot be repaired, the company reserves the right to replace it with a machine of the same specifications. In order to protect the rights and interests of consumers, consumers must personally send the machine (with the formal purchase invoice) to the NEWLINE authorized service center for maintenance. If you cannot show a regular purchase invoice, the machine shall be sent to the original dealer to carry out the warranty service.

If any of the following occur, it is not covered by the free warranty service of NEWLINE:

1. The original warranty label or bar code has been damaged, altered, torn, defaced or changed.
2. Use of parts not produced or sold by our company (such as power cable, data cable or other external devices) causes faults and damage.
3. The product is damaged due to improper installation or use of abnormal AC power.
4. Product faults caused by natural disasters (earthquake, flood, tsunami, etc.), human behavior or improper operation and the like.
5. Damage caused by use of illegal software or computer virus.
6. The product has been repaired or disassembled and re-assembled by technicians not authorized by our company.
7. The product is purchased in areas not covered by the warranty.
8. Product damage caused during customer transportation and delivery.
9. Improper use of LCD for a long time (such as not using the screen saver) results in screen burn.
10. Other problems and faults caused by abnormal use.

NEWLINE will charge repair service fee, material expense or test fee for LCD out of the warranty.

For products out of the warranty, if the consumer does not agree to repair after the engineer's testing and quotation, the test fee shall be paid.

III. Other Notes:

* Basic maintenance of the LCD screen

When the LCD screen is idle for a long time, the power of the LCD screen can be turned off temporarily by pressing the function key below the screen, which not only saves power, but also prolongs the service life of the LCD.

Do not touch the LCD surface with fingernails and sharp objects (hard objects) to avoid scratches or bad points, otherwise the warranty will be invalidated.

The surface of the LCD screen will absorb dust due to static electricity. It is recommended to clean your screen with a special wipe cloth for LCD screen. Do not press it with your fingers to avoid leaving fingerprints, and please wipe it gently. Do not wipe the LCD surface with a chemical cleaning agent, which will invalidate the warranty.

*About the characteristics of the LCD:

Each pixel (image element) on the LCD screen consists of a red dot, a green dot and a blue dot or accessory pixels. Each dot is driven by a separate transistor. The LCD screen for the LCD contains more than one million independent pixels. The LCD screen occasionally contains a few pixels that are not working properly. The LCD screen used in the NEWLINE product has passed strict inspection and conforms to the manufacturer's specifications. Even if a few pixel defects occur, the operation or use of the screen will not be affected.



newline

newline-interactive.com